



Excel



2013 FIFTH WHEELS & TRAVEL TRAILERS



OUTSTANDING CONSTRUCTION SETS US APART

- Wood frame construction is especially beneficial to full-timers because of its strength, durability, and comfort.
- Full 5/8" plywood floors are sturdy, quiet, and give your home a solid base.
- Heated basement area protects under-floor systems and stored items from weather extremes.
- Exclusive "Walk-Anywhere" one-piece seamless rubber roof (Winslow) and molded gel-coated fiberglass roof (Limited) are not only easy to maintain, but provide an exceptional barrier against the elements.
- Gel-coated fiberglass exterior gives your Excel a beautiful, easy-to-clean, durable outer skin that is virtually impervious to the elements.
- 2" x 4" tapered roof design provides outstanding run-off – shedding rain and snow more effectively and completely than flat roofs.
- R10 sidewall insulation and R17 floor and roof insulation help keep the coach cozy in winter and cool in summer, while also saving on heating and cooling costs.
- Standard pin height is adjustable from 41½" to 45½".
- Our exclusive "Drop Z" frame design provides a lower center of gravity for easy towing stability and more useful basement storage. We use a box tube frame for unbeatable strength and durability.

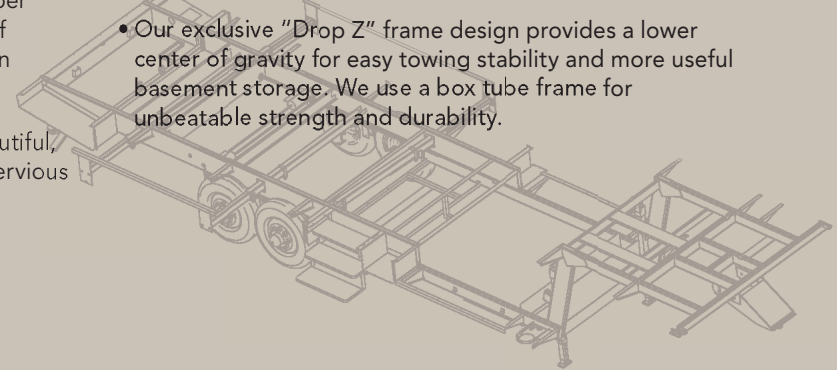

UNBEATABLE WARRANTIES



With Excel's Minus Ten Degree Guarantee, you can be sure your holding tanks, water tank, interior water lines and other essential plumbing won't freeze – all the way down to minus ten degrees!*

* See your dealer for complete explanation of product warranties. The Minus Ten Degree Guarantee is in effect on all 2008 and later models with Thermopane windows installed. Furnace must be in operation for guarantee to be in effect.



Excel's 2-Year Limited Warranty covers material and workmanship of the steel frame, wood structure, laminated sidewalls, roof, and other parts/assemblies manufactured by Peterson Industries, Inc. for two full years after your original date of purchase. It's our promise that your Excel is built to last. Equipment and appliances are covered by manufacture warranties.

Peterson Industries is proud to use these suppliers who share our commitment to quality and service:



Cummins Onan



VIZIO



Hehr International, Inc.





WINSLOW

Available in 28', 31', 34' and 37' models, Winslow sets the adventurous traveler up in style and affordable luxury. The bold profile and optional paint and graphics package make a statement. An interior wrapped in rich hickory or glazed maple woodwork, and comfortable amenities invite you to stretch out and unwind after a day spent exploring.

The Winslow Travel Trailer makes innovative use of Excel's groundbreaking "Drop-Z" I-Beam frame, providing more than 100 cubic feet of basement storage — space unheard of in the travel trailer industry!

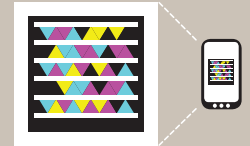

Get the free mobile app at <http://gettag.mobi>



LIMITED

If your idea of travel involves 5-star accommodations and a long list of innovative and convenient features, the Limited is for you. Standard features include many extras that are either optional or unavailable on other models, like a 42" HD LCD television, LED taillights, an industry-first pillowtop mattress with box springs, and so much more.



WILD CARGO

Bring your 4-wheeler, golf cart, motorcycle or snowmobile along, and you'll be set for fun wherever you go. The Wild Cargo's spacious garage area accommodates all this and more. Seating that folds into a double bed, and a drop-down overhead bunk offer plenty of room for guests. The beautiful interior surrounds you with all the creature comforts of home.







Shown with optional body paint.

WINSLOW

A WHOLE NEW EXPERIENCE

Affordable luxury is par for the course in our Winslow line, with standard features like a 42 inch LCD-HD TV, hickory woodwork, and a host of attractive options and unique features throughout every floorplan.

Available in 28, 31, 34 and 37 foot models, the Winslow features a bold exterior profile and graphics package that announces your arrival wherever you go. The fully enclosed and heated holding tank areas make the Winslow the best four-season units at any price. And our 35,000 BTU furnace, and 15,000 BTU air conditioner units are the biggest in the business. Plus every Winslow is covered by our exclusive Minus Ten Degree Guarantee, providing peace of mind that your tanks, water lines, and other essential plumbing fixtures won't freeze when the temperature drops.*

Excel is among the few fifth wheel manufacturers in the country to build a frame strong enough to support an optional Class 3 receiver hitch capable of pulling a 4,000 lb. boat. And abundant storage throughout the unit means you'll never have to sacrifice the things that make your travel plans extra enjoyable.

*See your dealer for complete explanation of product warranties. The Minus Ten Degree Guarantee applies to all 2008 and later models with Thermopane windows installed. Furnace must be in operation for guarantee to be in effect.

WINSLOW

A WHOLE NEW EXPERIENCE



Organizational features such as this nook desk in the 37 FLE provide computer space and handy storage.

The 2013 Winslow is designed for your total comfort and convenience.

Amenities can be tailored for the way you like to live and travel. The standard 8 cubic foot, 2-door refrigerator can be upgraded to a 10 cubic foot model or even an 18 cubic foot stainless steel residential refrigerator in most models. Add a convection microwave oven to speed up cooking plans, or a central vacuum system to make cleaning a breeze.

An optional whole house water filter makes everything taste better. And many Winslow floorplans offer an optional stacked washer and dryer unit.

The true, queen size pillowtop mattress fits standard sheets, and an optional box spring makes sleeping in your Winslow as comfortable as home.

From design to delivery, your family's comfort is our inspiration.



WINSLOW TT

Peterson Industries is proud to offer the Winslow Travel Trailer for the customer who prefers one-level living, and wants to maintain use of the truck bed.

Full-timers and serious RVers will find the storage solutions in the Winslow TT especially attractive. Storage problems associated with other travel trailers have been solved completely in the Winslow TT. In fact, it's the only travel trailer in the industry to offer 120 cubic feet of basement storage in the front third of the

coach. We achieve this by utilizing our exclusive "Drop Z" 8-inch I-Beam frame.

Available in two 33 foot models, Winslow TT floorplans are packed with the same cutting-edge design and spectacular features found in our 5th wheels. Optional electric front and rear stabilizer jacks make set up a breeze, and a convenient storage unit in the front accommodates dual 30-pound LP bottles.





DT33CKE

Optional bathrooms available. See page 19.

H **E**

DT33RLE

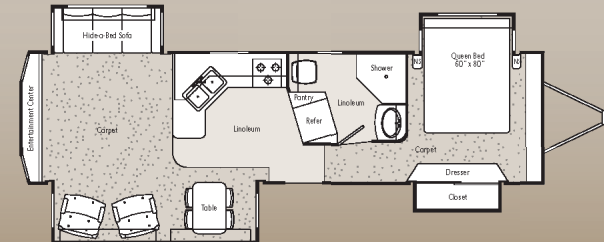
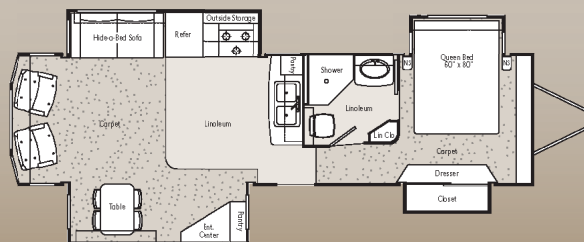



We ensure that every square inch of space is designed to maximize storage. You'll find large pantries, deep drawers and innovative storage that keeps you organized.



Our cabinet drawers feature full extension, ball bearing drawer glides and real wood sides, not sawdust board.



A residential style dresser offers plenty of easy-to-access storage at the foot of the bed.

WINSLOW

With eleven available floorplans in the Winslow line, you'll find a model that fits you perfectly. Three slide outs expand living space and provide a variety of spacious design possibilities.

Kitchens are offered in either wide-open or u-shaped designs. Hide-a-bed sofas are standard in all floorplans, including those with wraparound sofas. Some plans place the refrigerator against an interior wall for maximum living space. Nearly all floorplans offer a washer/dryer as an attractive option. And every inch has been utilized, with storage under the bed, in the overhead cabinets, behind the grandfather clock, and more!



Deep closets include shelving for additional storage space.



A one-piece, solid surface countertop, oil rubbed bronze or satin nickel fixtures, and undermount sink combines beauty and easy-clean convenience.



Halogen lighting adds a modern look, and lends a warm, inviting feel throughout the unit. Enjoy surround sound from the flush mount speakers.



Watch a movie on your optional 26 inch LCD-HD TV in the bedroom before turning in for the night.





Optional body paint in Espresso.

LIMITED

THE HIGHEST LEVEL OF LUXURY

Brimming with cutting-edge standard amenities and attractive options, Excel's luxurious Limited line represents the epitome of American ingenuity. Our 2013 models include fresh, clean lines for today's more contemporary traveler.

Glass and ceramic tile accent the kitchens of every Limited model. And, depending on your floorplan choice, you may find a clever pull-out cutting board, optional portable island, or expansive pantry with pull-out shelves.

The Limited provides the complete comfort and luxurious feel of a 5-star hotel, making it the optimal choice for the full-time and avid RVer. Its lasting quality means your Limited will serve you faithfully for many years to come.



LIMITED

THE HIGHEST LEVEL OF LUXURY

Every inch of the 2013 Limited is a sight to behold, with floorplans and décor choices that beckon to the traveling spirit.

An available wraparound sofa invites you to stretch out and enjoy a movie on the 42 inch LCD TV, or chat with friends in the comfortable living room. An optional fireplace accented with subway tile lends an added touch of luxury. Halogen lighting is standard, casting a warm, inviting feel throughout. Residential quality carpeting and flooring enhances the homelike feel.

The optional full body exterior paint package makes a striking impression in the park, campground, and on the road. When you choose a Limited, you receive top-of-the-line quality and innovation.



The pull-out spray faucet offers both convenience and style.



The 42 inch LCD wall mounted television extends to provide a great view from every seat with this optional swing arm mount.





Open floorplans accommodate guests in style. The portable island (above) gives extra work space or can be tucked away when more open space is desired.



Features that multi-task, such as this pullout desk, reveal extra storage and easily stows away when not in use.

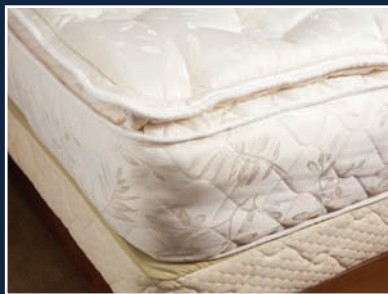

Excel is the only manufacturer in the industry to offer a pillowtop mattress and box spring.



Sofas are available in a variety of different fabric combinations and feature a standard hide-a-bed with innerspring mattress.



Our optional EZ-up coffee table can be extended and used as a writing desk or an additional place setting.



Most models feature a full backsplash behind the range to protect the wall



LIMITED

Amenities that are options in other lines are standard in the Limited, like premium quality carpeting, a light-blocker vent cover in the bedroom, and a whole-house water filtration system. Add an optional fireplace for added warmth and hospitality. And optional remote control window blinds allow you to add light or privacy with a single touch.

The one-piece fiberglass shower is roomy and easy-to-clean. A matching vanity with under-mount ToughStone sink, including a matching sink cover, and a standard china toilet complete the beautiful bathroom.



Optional body paint in Black Almond and Espresso.



The optional quad door refrigerator features 12 cubic feet of space.



Vinyl and wood laminate flooring options are easy to maintain, feel great underfoot, and are beautiful to behold.



A full-length glass paneled bedroom door is an attractive option, with an accordion blind and valance for a designer touch.



The digital SeeLevel monitor lets you check water levels quickly and easily.



WILD CARGO

ACTION ON THE GO

If your ideal vacation includes a motorcycle, golf cart, 4-wheeler or other off-road toys, without sacrificing the comforts of home, the Wild Cargo is perfect for you.

The Wild Cargo includes the same features as our Winslow line, like solid surface countertops and quality-constructed furniture, which distinguishes it from other toy haulers that are built for function alone. The 10½ foot garage accommodates two motorcycles or even a Smart Car, since the ramp door is rated for 2,000 pounds. The garage can also be used as an office, patio, second bedroom, hobby or exercise room, making the Wild Cargo perfect for extended stays or full-time use.

Guests will find plenty of room to call their own in the Wild Cargo. Move the table in the garage area, and the optional sit-and-sleep benches fold into a bed. The top bunk moves down when you need it, and up when you don't. Cabinet space above the garage door in the living area is also great for storing gear.

Three available floorplans include commercial grade rubberized flooring, and options like a built-in generator and 30-gallon fuel cell for worry-free camping in remote areas. And every Wild Cargo is covered by our exclusive Minus Ten Degree Guarantee, providing peace of mind that your tanks, water lines, and other essential plumbing fixtures won't freeze when the temperature drops.* An optional full-body paint package matches your adventurous spirit.

*See your dealer for complete explanation of product warranties. The Minus Ten Degree Guarantee applies to all 2008 and later models with Thermopane windows installed. Furnace must be in operation for guarantee to be in effect.



An easy-open aluminum framed ramp door is rated for 2000 pounds.



An optional pull-down patio screen keeps the bugs out.



The bathroom includes a solid surface top with under-mount lavatory sink.

Choose the optional loft area above the entertainment center for added sleeping quarters.



The only thing as beautiful as nature itself is our Wild Cargo with optional full body paint. The paint scheme shown is Silver Mountain.



The sit-and-sleep benches fold down into a bed, and the bunk moves up and out of the way when not in use.

W39TKE

Optional bathrooms available. See page 19.

H E

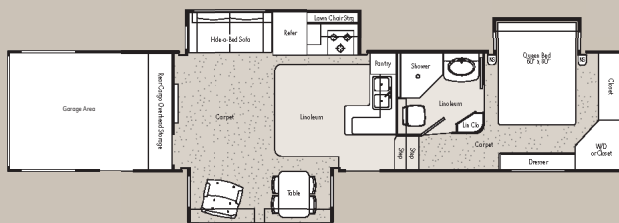

W41GKE

Optional bathrooms available. See page 19.

H E O

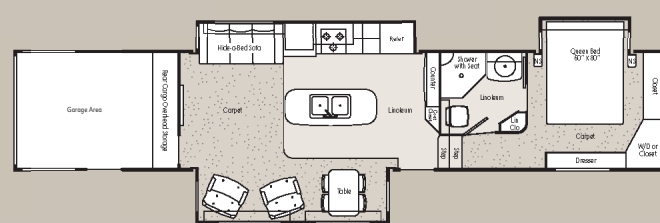

W41RLE

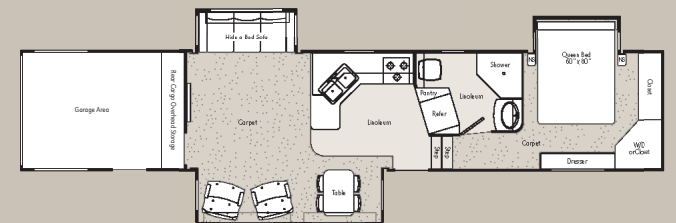

WINSLOW FLOORPLANS

D28RKW

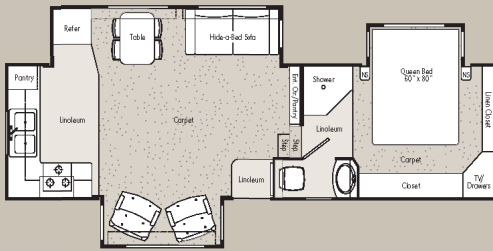

D31RLE

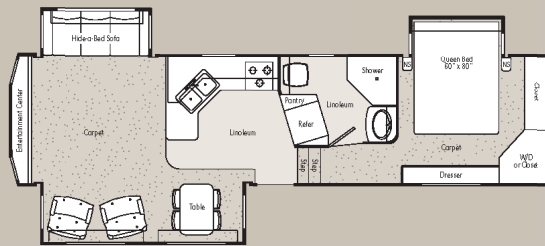

D34IKE

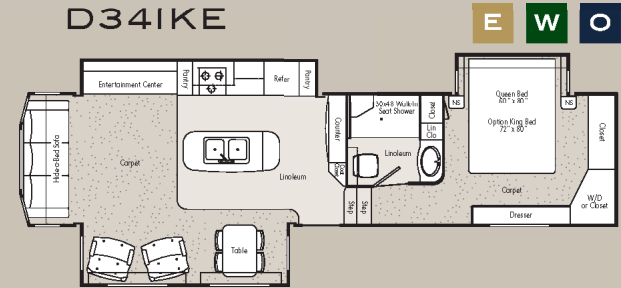

D31IKE

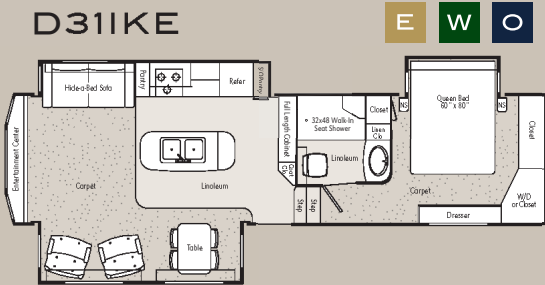

D31RSE

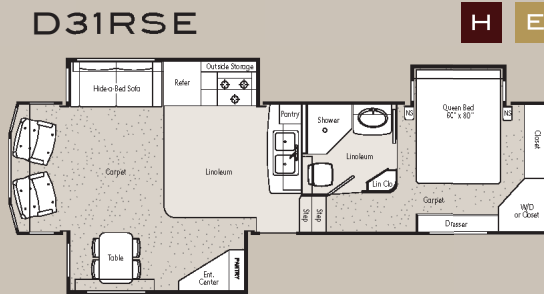

D34IKR

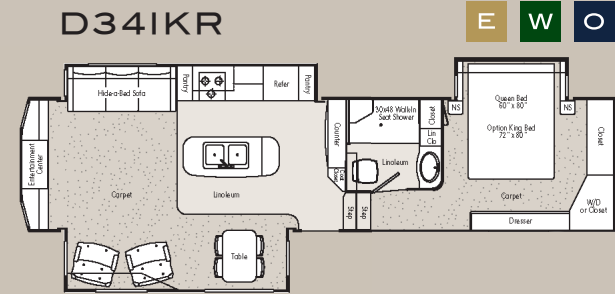

LIMITED FLOORPLANS

L31IKE

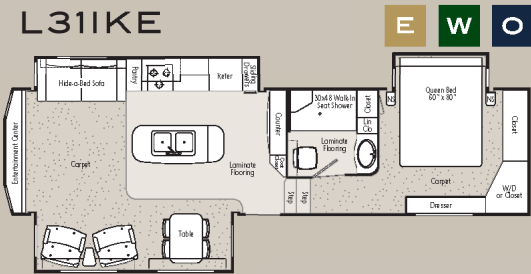

L31RSE

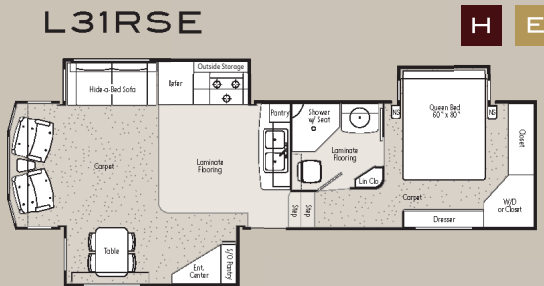

L34IKE

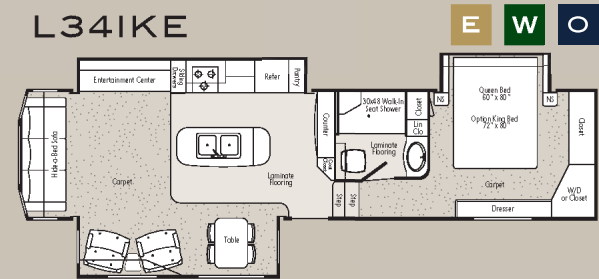

L31RLE

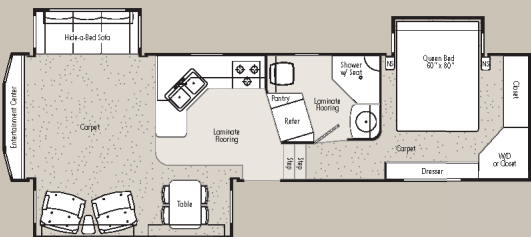

L33FKE

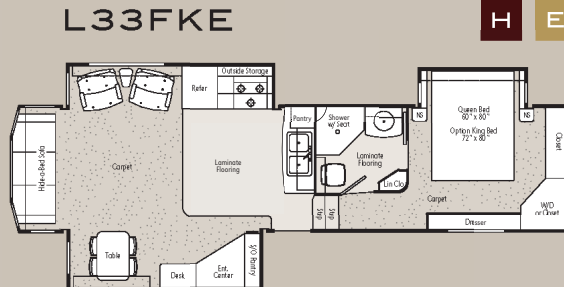

L34IKR

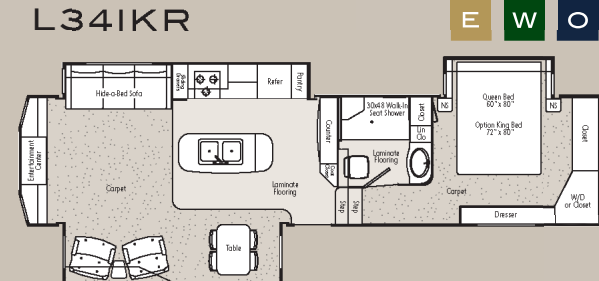

D34FKE

H E

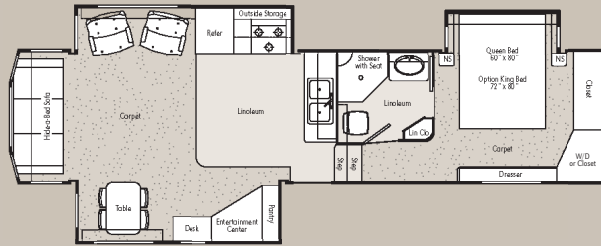

D34RLE

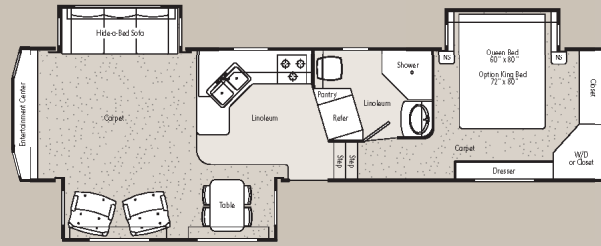

D37IKE

E W O

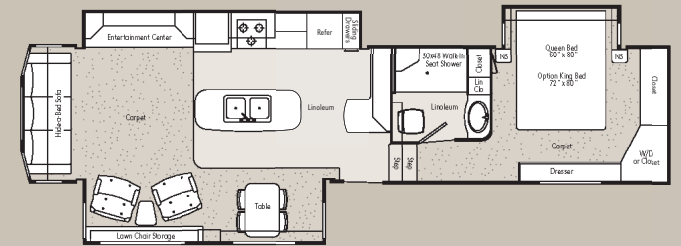

D34RKM

H E W O

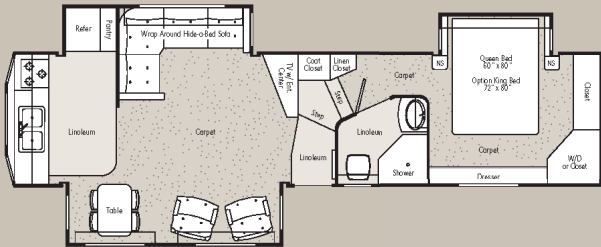

D37FLE

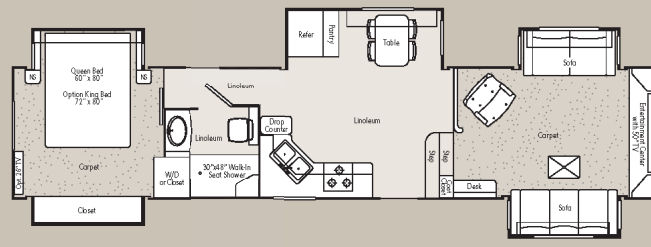

D37RKM

H E W O

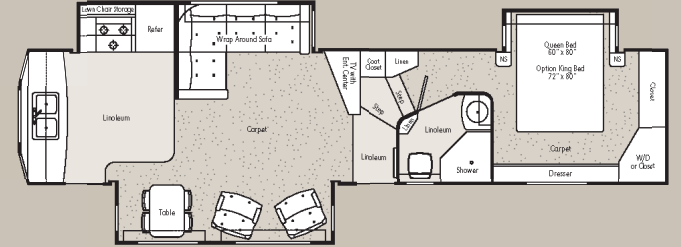

L36GKE

H E O

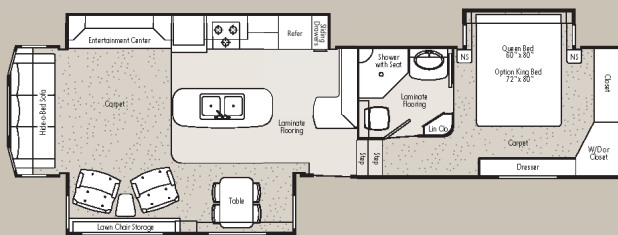

L36GKM

H E W O

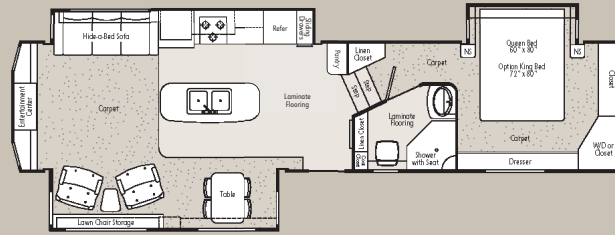

L36RKM

H E W O

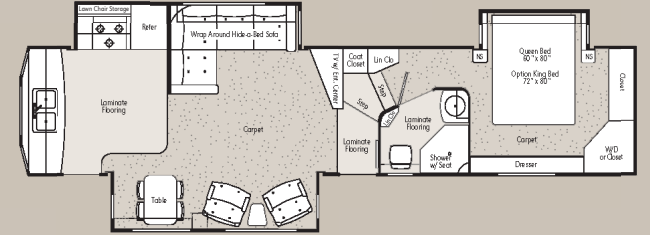

BATHROOM OPTIONS

When choosing an optional bathroom, additional charges apply.

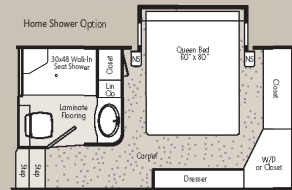

H HOME SHOWER

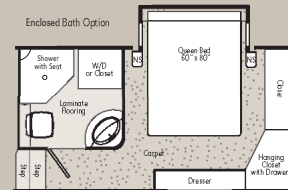

E ENCLOSED BATH

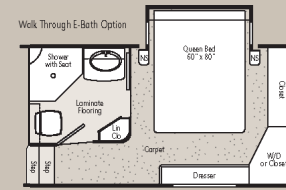

W WALK THROUGH ENCLOSED BATH

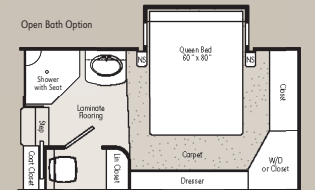

O OPEN BATH

RV ENHANCING AMENITIES AND OPTIONS



The central vac with powerhead and VacPan makes cleaning a breeze!



Enhance your digital entertainment experience with an automatic satellite system for DISH Network or DIRECTV.



Commercial grade rubberized flooring in the basement makes cleanup easy.

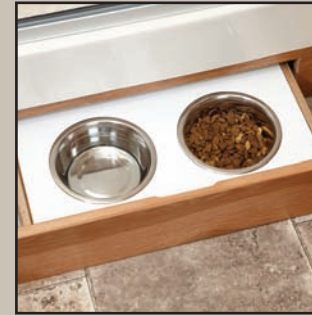

Your pets will appreciate an easy to access feeding station located below the shower in some models. Push it in when not in use.



Maximized storage is part of every floorplan, including this under-seat compartment on all the dining chairs.



Stainless steel appliances are included with the optional Residential Refrigerator Package (N/A separately).



The keyless locking system offers effortless programming and a secure, convenient way to safeguard your RV.



We've added even more strength and stability with struts on heavy access doors. Plus most models offer slide out basement storage.



With our motorhome style fully automatic leveling system, just push the "Automatic Level" button and watch it work!



Our optional lateral arm awning operates with a remote control and features a wind sensor control that will automatically retract itself in windy conditions.



Traditional-style sofa (Optional)



Contemporary-style sofa (Standard)

DECORATOR PACKAGES

A variety of wood finishes, upholstery, window fabrics, and floor coverings are available for every taste – from contemporary to traditional and everything between. Every choice is designed for comfort, durability, and easy care and maintenance.

See your dealer for actual fabric samples and decorator package options.



We also offer disc brakes without the MorRyde suspension.



We offer an optional dinette booth in many models



Pivot-EZ sewer hose compartment ensures you'll never have to disconnect your hose from the RV.



The Glide Ride Pin Box absorbs bumps and jolts through a gravity, self-centering parallel linkage system.



Our factory installed Class III receiver hitch is capable of pulling a 4,000lb boat or carrying up to 400lb direct weight.



Electric stabilizer jacks make setting up your Winslow a breeze and saves your back and shoulders.



Our multi-function utility center provides easy access to shut off individual faucets, change water filters, replace vacuum bags, disconnect the battery and more.



Haul your motorcycle anywhere with our frame-mounted Hydalift™. Available on models 34' and shorter.

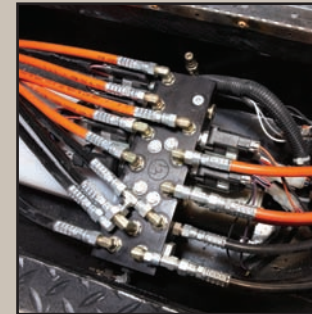

Our uni-body hydraulic valve system for slide rooms and jacks include individual functionality and a manual override.



Gel-coated access doors are a full 1-3/8" thick, offering longer life, better insulation and a tight seal for protection from moisture and insects.

FLOORING



Vinyl flooring by Beauflor® is standard in the Winslow and Wild Cargo. Hand-scraped hickory wood laminate flooring is standard in the Limited.

CABINETS



Choose between the upscale elegance of our new glazed maple, or the rustic feel of solid hickory for your cabinets.

VALANCES

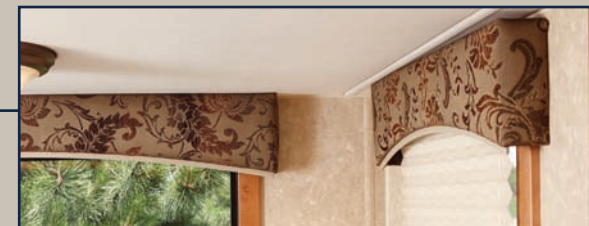

Window valances with duplex shades can be customized to showcase your choice of fabric. All windows have wood frames for a polished look.

WINSLOW

MODEL:	28RKW	31IKE	31RLE	31RSE	34FKE	34IKE	34IKR	34RKM	34RLE	37FLE	37IKE	37RKM	DT33CKE	DT33RLE
Base Unit Wt. (W/O Opt.)	11,600	12,600	12,280	11,540	13,180	13,160	13,180	13,160	13,390	14,450	13,800	14,100	10,990	10,990
Unloaded Vehicle Wt. (W/O Water)	11,900	12900	12580	11840	13,480	13,460	13,480	13,460	13,690	14,750	14,100	14,400	11,290	11,290
Hitch Weight (W/O Water)	2,500	2690	2570	2020	2,640	2,380	2,640	2,380	2,380	2,750	2,750	2,500	940	940
Weight on Axles	9,400	10,210	10,010	9,820	10,840	11,080	10,840	11,080	11,310	12,000	11,350	11,900	10,350	10,350
Combined Axle Weight Rating	12,000	14000	14000	14000	14,000	14,000	14,000	14,000	14,000	15,000	15,000	15,000	12,000	12,000
Payload Capacity	3,100	4,600	4,920	5,660	4,020	4,040	4,020	4,040	3,810	4,000	4,650	4,350	2,210	2,210
Maximum GVWR	15,000	17,500	17,500	17,500	17,500	17,500	17,500	17,500	17,500	18,750	18,750	18,750	13,500	13,500
Height (Incl Vents & A/C)	151"	151"	151"	151"	151"	151"	151"	151"	151"	154"	151"	151"	143"	143"
Overall Length (Pin to Bumper)	29' 5"	32' 11"	32' 11"	32' 11"	35' 5"	35' 5"	35' 5"	35' 5"	35' 5"	38' 9"	37' 2"	37' 2"	34' 3"	34' 3"
Square Feet	309.5	341.0	341.0	341.0	356.5	356.5	356.5	356.5	356.5	377.0	390.1	390.1	331.0	331.0
Fresh Water Capacity (Incl WH)	71	88	88	88	88	88	88	88	88	88	88	88	64	64
Gray Water Capacity	55	67	67	67	67	67	67	67	67	44	67	67	67	67
Black Water Capacity	40	44	44	44	44	44	44	44	44	44	44	44	44	44
In-Line Central Air	15M	15M	15M	15M	15M	15M	15M	15M	15M	15M	15M	15M	15M	15M
Furnace BTU	35M	35M	35M	35M	35M	35M	35M	35M	35M	40M	40M	40M	35M	35M
Bedroom Interior Height	6' 5"	6' 5"	6' 5"	6' 5"	6' 5"	6' 5"	6' 5"	6' 5"	6' 5"	7' 6"	6' 5"	6' 5"	6' 10"	6' 10"
2 Pc. Stacking Washer/Dryer	N/A	OPT	OPT	OPT	OPT	OPT	OPT	OPT	OPT	OPT	OPT	OPT	N/A	N/A
Electric Fireplace	N/A	OPT	OPT	OPT	OPT	OPT	OPT	OPT	OPT	OPT	OPT	OPT	OPT	OPT
Awning Size	14'	16'	16'	15'	17'	16'	17'	17'	16'	17'	17'	17'	14.5'	14.5'

WINSLOW TT

LIMITED

MODEL:	31IKE	31RLE	31RSE	33FKE	34IKE	34IKR	36GKE	36GKM	36RKM	W39TKE	W41RLE	W41GKE
Base Unit Wt. (W/O Opt.)	12,600	12,740	12,740	13,500	13,680	13,500	14,100	14,100	14,100	14,740	15,300	16,500
Unloaded Vehicle Wt. (W/O Water)	12,900	13,040	13,040	13,800	13,980	13,800	14,400	14,400	14,400	15040	15600	16800
Hitch Weight (W/O Water)	2,880	2,740	2,740	2,720	2,760	2,720	2,790	2,790	2,790	2860	2950	2553
Weight on Axles	10,020	10,300	10,300	10,960	11,220	10,960	11,610	11,610	11,610	12,180	12,650	14,247
Combined Axle Weight Rating	14,000	14,000	14,000	14,000	14,000	14,000	15,000	15,000	15,000	18000	18000	18000
Payload Capacity	4,600	4,460	4,460	3,700	3,520	3,700	4,350	4,350	4,350	5,960	5,400	4,200
Maximum GVWR	17,500	17,500	17,500	17,500	17,500	17,500	18,750	18,750	18,750	21,000	21,000	21,000
Height (Incl Vents & A/C)	151"	151"	151"	151"	151"	151"	151"	151"	151"	153"	153"	153"
Overall Length (Pin to Bumper)	32' 11"	32' 11"	32' 11"	34' 4"	35' 5"	35' 5"	37' 2"	37' 2"	37' 2"	40' 5"	42' 1"	42' 11"
Square Feet	341.0	341.0	341.0	364.4	367.0	364.4	390.1	390.1	390.1	399.8	416.0	424.0
Garage Length	-	-	-	-	-	-	-	-	-	10' 6"	10' 6"	10' 6"
Living Area Int. Height	-	-	-	-	-	-	-	-	-	8' 3 1/2"	8' 3 1/2"	8' 3 1/2"
Fresh Water Capacity (Incl WH)	88	88	88	88	88	88	88	88	88	88	88	88
Gray Water Capacity	67	67	67	67	67	67	67	67	67	67	67	67
Black Water Capacity	44	44	44	44	44	44	44	44	44	44	44	44
In-Line Central Air	15M	15M	15M	15M	15M	15M	15M	15M	15M	15M	15M	15M
Furnace BTU	40M	40M	40M	40M	40M	40M	40M	40M	40M	40M	40M	40M
Bedroom Int. Height	6' 5"	6' 5"	6' 5"	6' 5"	6' 5"	6' 5"	6' 5"	6' 5"	6' 5"	6' 5"	6' 5"	6' 5"
2 Pc. Stacking Washer/Dryer	OPT	OPT	OPT	OPT	OPT	OPT	OPT	OPT	OPT	OPT	OPT	OPT
Electric Fireplace	OPT	OPT	OPT	OPT	OPT	OPT	OPT	OPT	OPT	OPT	OPT	OPT
Awning Size	16'	16'	16'	16'	16'	16'	16'	16'	16'	17'	16'	17'

WILD CARGO

2013 OPTIONS AND STANDARD FEATURES

Each Excel model is geared to meet the expectations, needs and budgets of different RV buyers. It's not a matter of one line being "better" than another, but more a question of which line best meets your lifestyle. The chart below compares the standard and optional features of our three lines. Rest assured, however, that whether you pull a Winslow, Limited or Wild Cargo, your fifth wheel comes with one standard feature no other manufacturer can offer — the legendary value of Excel!

W=Winslow L=Limited WC=Wild Cargo

Construction and Exterior Features	W	L	WC
Full Body Paint	Opt	Opt	Opt
Fully Enclosed and Heated Underbelly	Std	Std	Std
Exclusive -10 Degree Freeze Guarantee	Std	Std	Std
Utility Center w/Water Manifold	Std	Std	Std
2 - 8" Exterior Scene Lights	Std	Std	Std
Manual Awning	Std	-	Std
Power Awning (w/o Wind Sensor)	Opt	-	Opt
Electric "Lateral Arm" Awning W/Wind Sensor	-	Opt	-
16" Aluminum Wheels & Goodyear Tires	Std	Std	Std
Dual 30# Bottles	Std	Std	Std
Dual 40# Bottles	Opt	Opt	Opt
Gel-Coated Fiberglass Exterior, Front & Rear Cap	Std	Std	Std
Fiberglass Front Cap Designed for Increased Turning Radius	Std	Std	Std
Gas Struts on Access Doors	Std	Std	Std
1-3/8" Thick Radius Gel-Coated Access Doors	Std	Std	Std
"Drop Z" Box Tube Frame Construction (No I-Beam)	Std	Std	Std
Frameless Tinted Thermo-Pane Windows	Std	Std	Std
Walk Anywhere One-Piece Seamless EPDM Roof	Std	-	Std
Walk Anywhere Molded Gel-Coated Fiberglass Roof	-	Std	-
LED Tail Lights	-	Std	-
35M BTU Furnace With In-Floor Ducting	Std	-	Std
40M BTU 2-Stage Furnace	Opt	Std	Opt
Lawn Chair Storage (Most Models)	Opt	Std	Opt
Steel Generator Box ONLY	Opt	Std	Opt
Class III Receiver Hitch (N/A in Canada)	Opt	Opt	-
NevRLube Axles and Shock Absorbers	Std	Std	Std
Disc Brakes - 17.5" "J" Tires	Opt	Opt	Opt
Mor-Ryde Susp. w/Disc Brakes - 17.5" "J" Tires	-	Opt	Opt
Glide Ride Pin Box	Opt	Opt	Opt
Hydralift Motorcycle Carrier (34' & Below)	Opt	Opt	-

Interior Construction Details	W	L	WC
Linoleum in Bathroom, Kitchen & Entry	Std	-	Std
Residential Quality Carpet With 8 lb. Rebond Pad	Std	Std	Std
Premium Carpet	Opt	Std	Opt
Residential Laminate Flooring in Bath, Kitchen & Entry	-	Std	-
Hickory Interior	Std	Std	Std
Glazed Maple Interior	Opt	Opt	Opt
Ball Bearing Drawer Glides w/Wood Sides (No Sawdust Board)	Std	Std	Std
Solid Wood Face Frames, Screwed Together Not Stapled	Std	Std	Std
Cedar Lined Bedroom Closet	-	Std	-
Eloquent Window Valances w/Solid Wood Casings	Std	Std	Std
MCD Ultimate MANUAL Shades	-	Opt	-
MCD Ultimate Remote Shades	-	Opt	-
Recessed Halogen Ceiling Lighting	Std	Std	Std
French Door With Night Shade in Hall	Opt	Opt	Opt
New 6' 5" Ceilings in Level Bed and Bath Deck Area	Std	Std	Std
Padded Ceiling	Opt	Std	Opt
Solid-surface countertops w/undermount sink	Std	Std	Std
Full Decorative Backsplash in Kitchen	-	Std	-
Undermount Lavatory Sink (Incl. Cover in Ltd)	Std	Std	Std

Appliances and Accessories	W	L	WC
Microwave Oven	Std	-	Std
Convection Microwave Oven	Opt	Std	Opt
Recessed 3-Burner Range with Sealed Burner & Piezo Ign	Std	Std	Std
8 Cu Ft 2-Door Refrigerator	Std	-	Std
10 Cu Ft 2-Door Refrigerator	Opt	Std	Opt
12 Cu Ft 4-Door Refrigerator (N/A in all Models)	Opt	Opt	Opt
18 Cu Ft Residential Refrigerator w/Stainless Appliances (N/A on all Models)	Opt	Opt	Opt
Cable TV Prewire & TV Antenna With Booster	Std	Std	Std
Pre-Wire Ground Based AND Roof Mount Sat	Std	Std	Std
Winegard "Traveler Sat System for Dish or DirecTV	Opt	Opt	Opt
19" or 26" LCD TV in Bedroom (Depending on Model)	Opt	Opt	Opt
42" LCD TV in Livingroom (Most Models)	Std	Std	Std
Swing Arm Mount for LCD TV	Opt	Opt	Opt
Monitor Panel	Std	-	Std
SeeLevel Electronic Tank Monitoring System	-	Std	-
Central Vacuum System w/Powerhead and VacPan	Opt	Opt	Opt
Electric Fireplace (N/A in All Models)	Opt	Opt	Opt
Washer/Dryer Ready	Std	Std	Std
2-Piece Front Load Washer/Compact Dryer	Opt	Opt	Opt
Motorized SENSAR TV Antenna	Opt	Opt	Opt

Living/Dining Furniture and Accessories	W	L	WC
Rocker/Glider Swivel Recliners	Std	Std	Std
Hide-a-Bed in Sofa	Std	Std	Std
Sofa Caddie (N/A in Wrap-Around Sofa)	Opt	Opt	Opt
Computer Station (Most Models)	Std	Std	Std
"E-Z" Up Coffee Table	Opt	Opt	Opt
End Table Between Recliners	Opt	Std	Opt
Solid Wood Dinette Table With Pedestal Base	Std	Std	Std
Dining Booth (Instead of Table and Chairs)	Opt	Opt	Opt

Bedroom/Bathroom Amenities	W	L	WC
Queen Innerspring Mattress With Comforter, Pillows, & Shams	Std	Std	Std
Pillow Top Mattress	Std	Std	Std
Box Springs Under Mattress	Opt	Std	Opt
King Size Bed (Some Models)	Opt	Opt	Opt
Nightstand on each side of the bed	Std	Std	Std
Lightblocker Vent Cover in Bedroom	Opt	Std	Opt
Lift-Up Bed for Additional Storage	Std	Std	Std
Large One-Piece Fiberglass Shower With Glass Door	Std	Std	Std
China Toilet	Std	Std	Std

Plumbing	W	L	WC
Actively Heated Holding Tanks, Water Tank, Valves, Water Lines	Std	Std	Std
16 Gallon Output Gas/Electric DSI Water Heater With Bypass	Std	Std	Std
Whole House Water Filtration System	Opt	Std	Opt
ShurFlo High Volume Demand Water Pump	Std	Std	Std
Pivot-EZ Sewer Hose Comp. w/20' Hose	Opt	Opt	Opt

Electrical and Misc.	W	L	WC
60 Amp Converter (55A in 28')	Std	Std	Std
50 Amp Service	Std	Std	Std
Flush Floor New Generation Hydraulic Slide-Out System	Std	Std	Std
New Generation Hydraulic Front Jacks	-	Std	-
12V Electric Front Jacks	Std	-	Std
H&H Electric Rear Stabilizer Jacks	Opt	-	Opt
Independent Hydraulic Leveling System	Opt	Opt	Opt
Motorhome Style Fully Automatic Leveling System	Opt	Opt	Opt
Keyless Entry	Opt	Opt	Opt
Generator Ready for Onan (Incl. Box, Energy Command Monitor)	Opt	Opt	Opt
5500W LP Onan Generator (Includes Generator Ready)	Opt	Opt	Opt
High Volume Fan with Rain Sensor	Std	Std	Std
15,000 BTU Roof Air Conditioner With "Chill Grille"	Std	-	Std
15,000 BTU Roof Air Conditioner w/Concealed Return Air	-	Std	-
Wired for 2nd Air Conditioner in Bedroom (33' and Above)	Std	Std	Std
Ducted 2nd Air Conditioner (13.5M BTU Low Profile)	Opt	Opt	Opt
Heat Pump Instead of Air Conditioner	Opt	Opt	Opt





Manufactured by Peterson Industries, Inc.
616 E. Hwy. 36, Smith Center, Kansas 66967
800-368-3759 • www.excelrvs.com

VISIT US ONLINE!

EXCELRVS.COM

Visit our award winning website for in-depth information on our entire line of Excel RVs, including exterior views and floorplans with complete specs. You'll find model and feature photos, and so much more!

- Videos of models and features
- Model comparison feature
- Maintenance tips
- Pricing calculator
- Dealer locator
- Testimonials

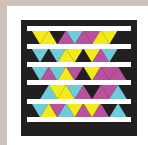

Get the free mobile app at
<http://gettag.mobi>

